







33 500 670



- saillie 130 mm
- bec déverseur fixe
- jet rectangulaire enrichi en air
- hauteur de robinetterie 154 mm
- hauteur jusqu'au mousseur 80 mm
- diamètre de percement 35 mm
- 2x flexible de pression M 10 x 1 vissé, étanchéité contrôlée
- débit maxi. 7 l/min
- sans plomb
- Ce produit contribue au respect des exigences des systèmes d'évaluation des bâtiments écologiques, par exemple LEED®, BREEAM®, DGNB

Convient uniquement à un lavabo avec trop-plein.

	Chrome	33 500 670-00
	Platine brossé	33 500 670-06
	Platine	33 500 670-08
	Laiton brossé (Or 23cts)	33 500 670-28
	Chrome brossé	33 500 670-93
	Dark Platinum brossé	33 500 670-99

33 500 670

mm [inches]



Diagramme de débit



Certificats

WRAS_1806010.

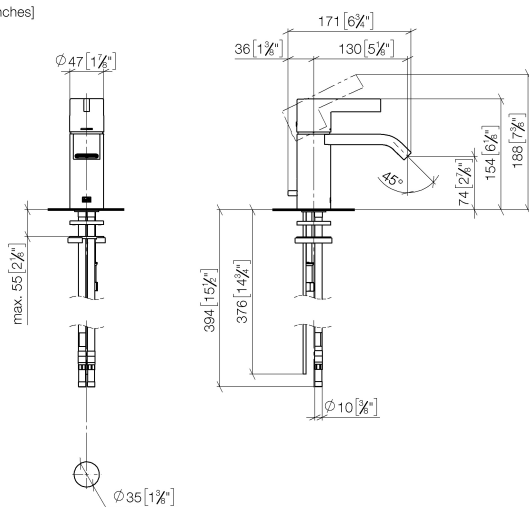
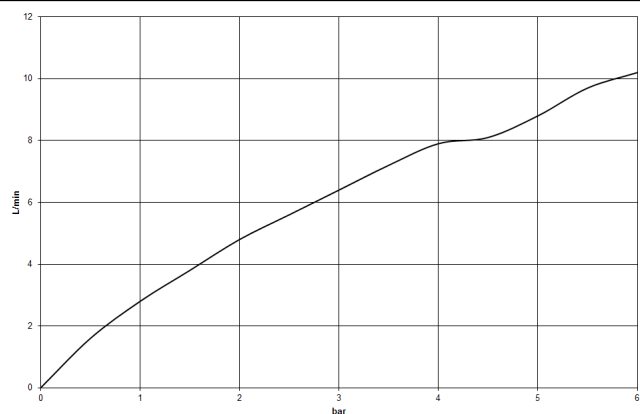
ETA_19965.

LGA_19485.

GDV_0400311.

WRAS_240202005.

33 500 670

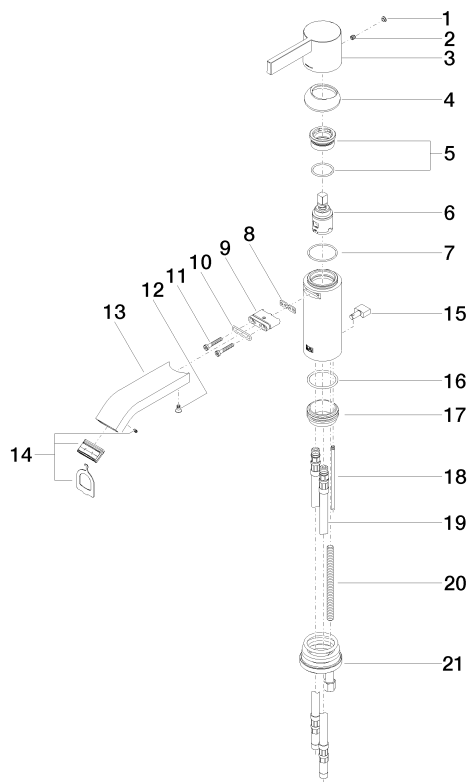

22 ———— Mitigeur für 14.11.01.201.00.04

33 500 670

Liste des pièces de rechange

N°	Article Numéro	Désignation	Fréquence de montage	Délai de livraison
1	90 31 20 087 00-00	bonde de fond	1	10
2	90 31 11 030 00 90	tige	1	2
3	09 20 67 003-00	poignée	1	10
4	09 28 30 019-00	hotte	1	10
5	90 23 10 066 00 90	écrou	1	2
6	90 15 05 042 00 90	cartouche	1	2
7	09 14 10 102 90	joint	1	2
8	09 14 03 131 90	joint	1	2
9	09 11 03 061 90	raccord	1	2
10	09 14 10 053 90	joint	1	2
11	09 30 30 084 90	vis	2	2
12	09 30 30 116 90	vis	1	2
13	09 28 22 239-00	bec déverseur	1	10
14	90 29 03 045 00 90	mousseur	1	2
15	09 20 67 002-00	poignée	1	10
16	09 14 10 119 90	joint	1	2
17	09 28 10 109-07	anneau	1	30
18	09 31 09 080-00	tige	1	10
19	04 30 04 016 00 90	flexible	2	60
20	09 31 11 012 90	tige	1	2
21	04 30 11 085 88 90	set de fixation	1	2
22	90 11 01 001 00-00	garniture d'écoulement	1	10